

Module top sheet

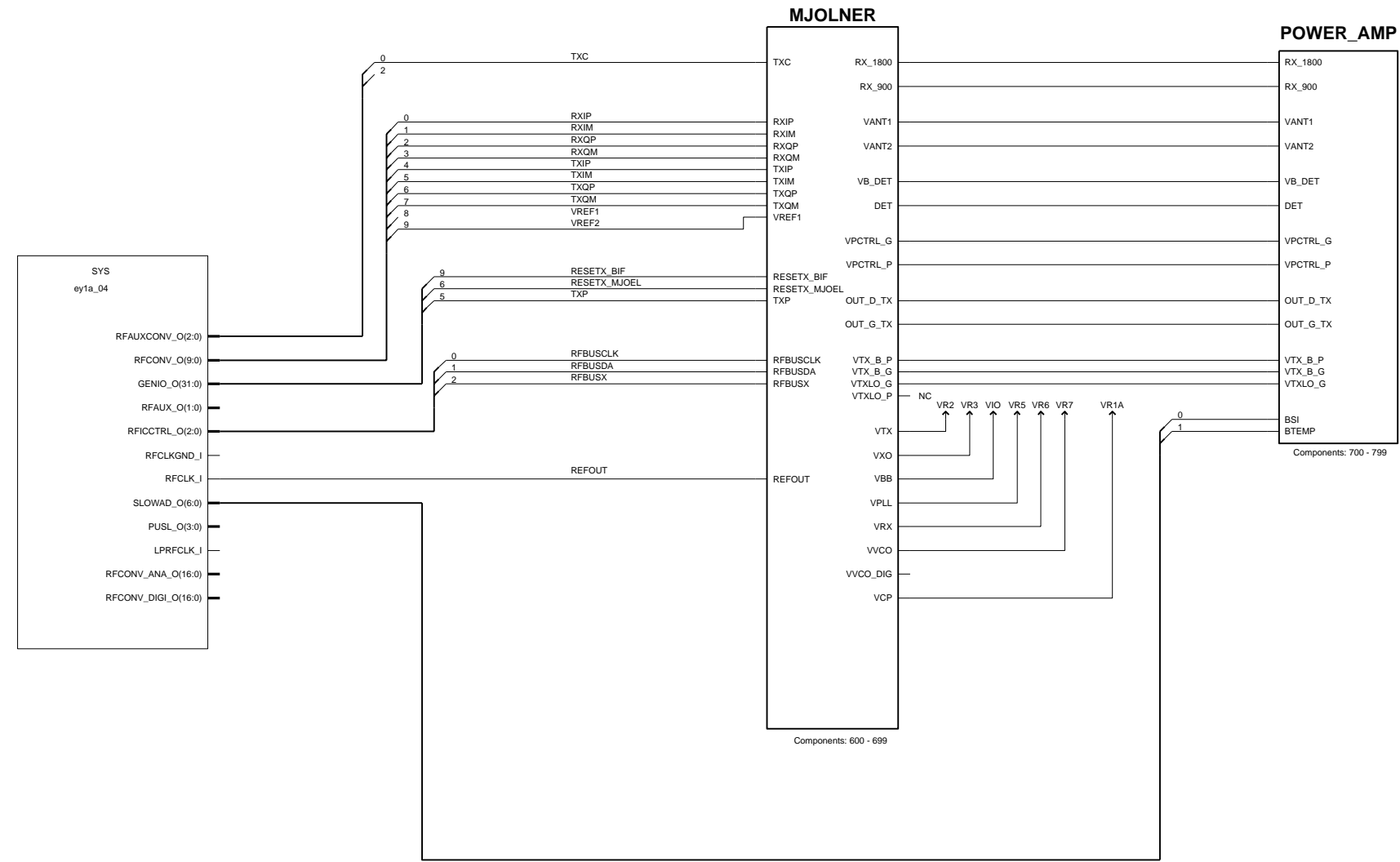

# Shielding's cans

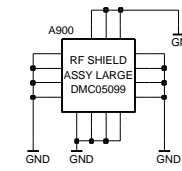
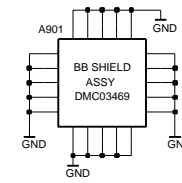
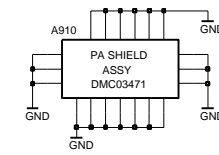
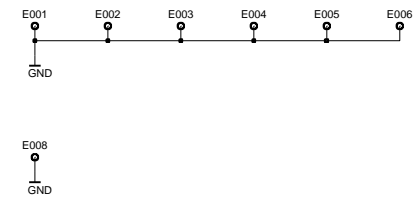

BB top sheet

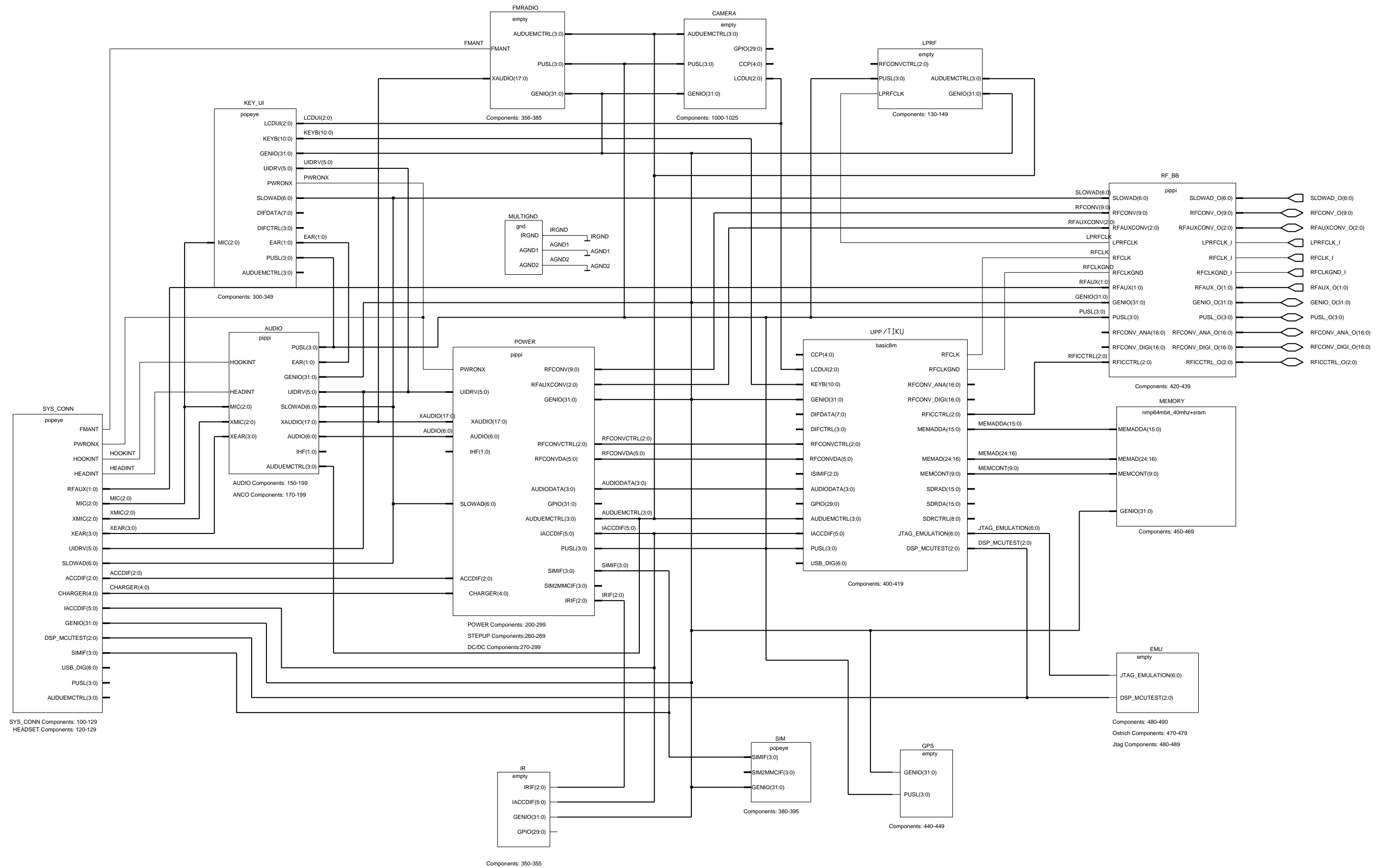

# System connector

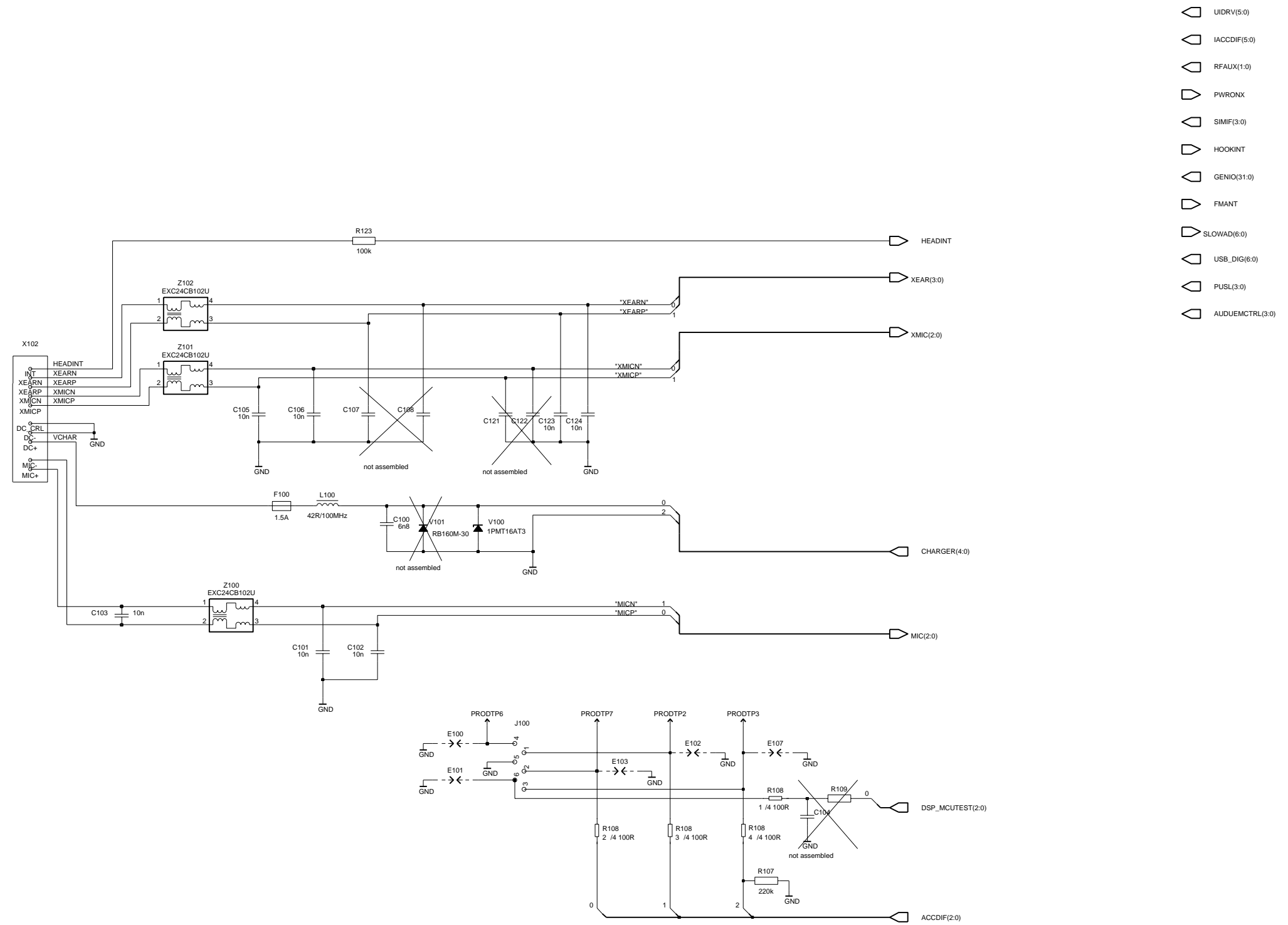



SIM

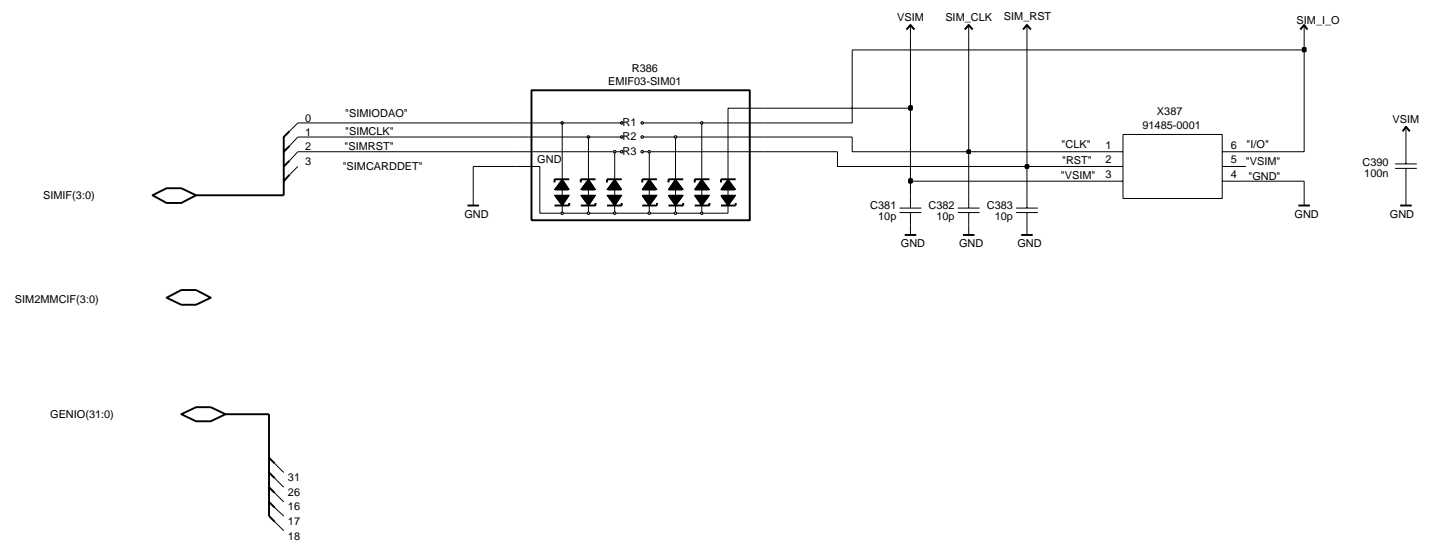



# Vcore

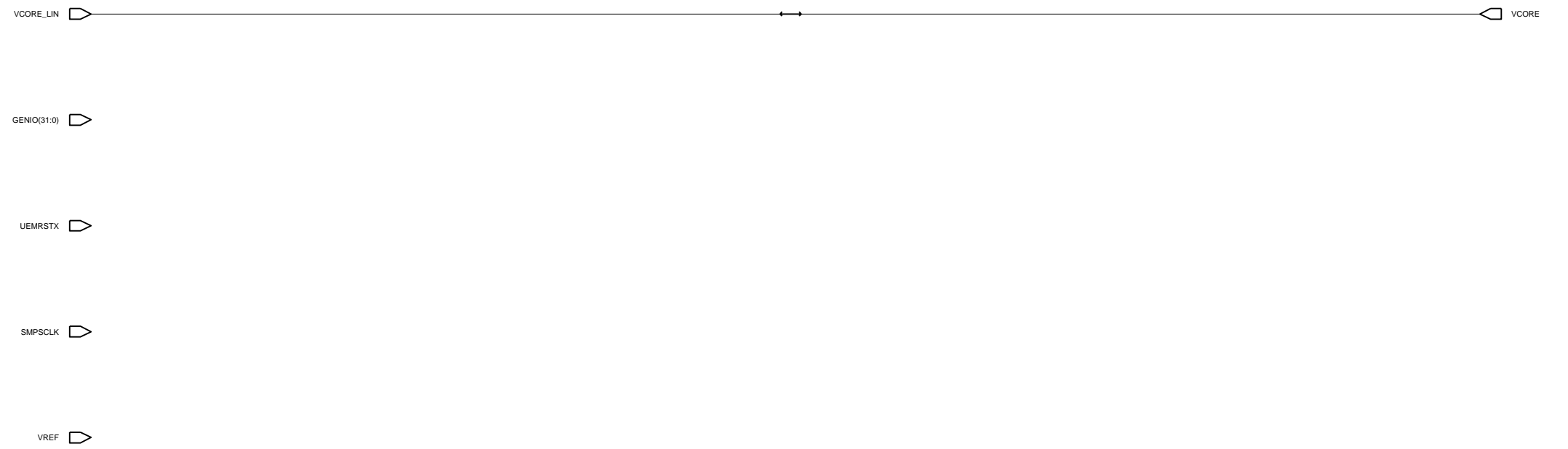



# Vbat filter

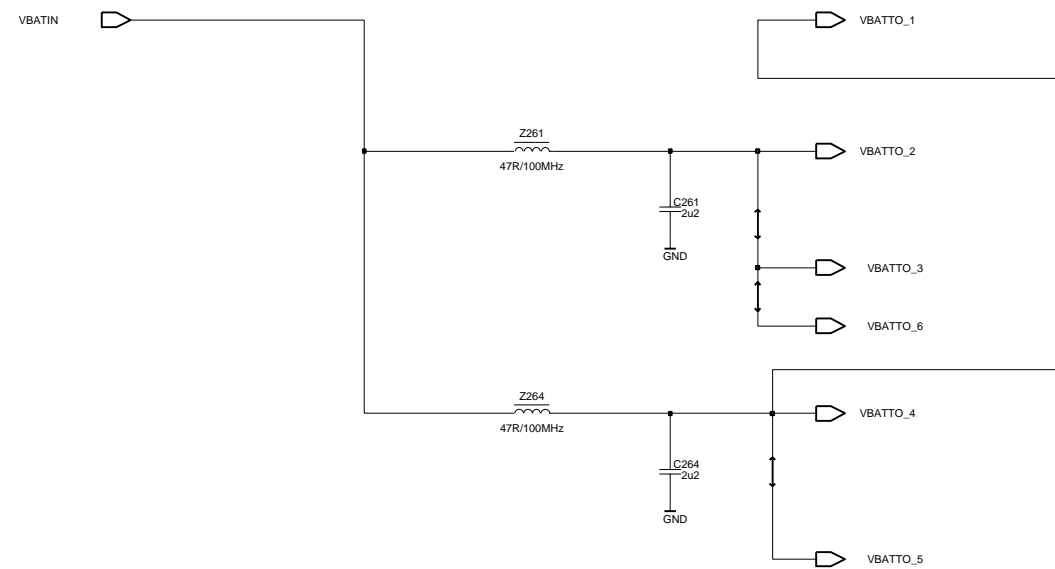

# UEM charge pump

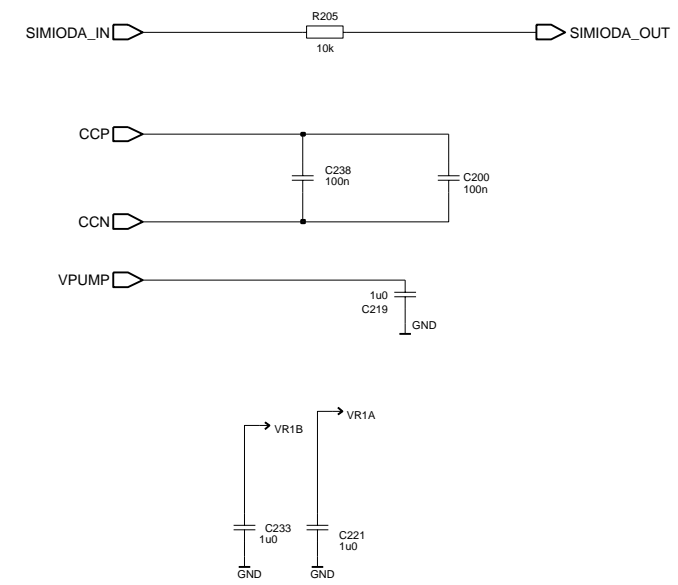



# UPP decoupling

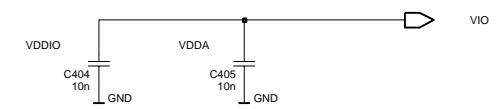
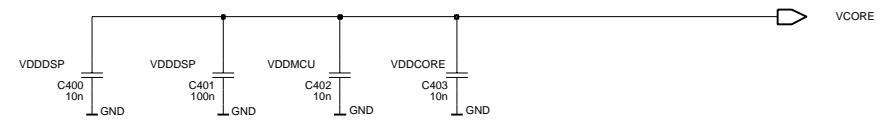

# Memory

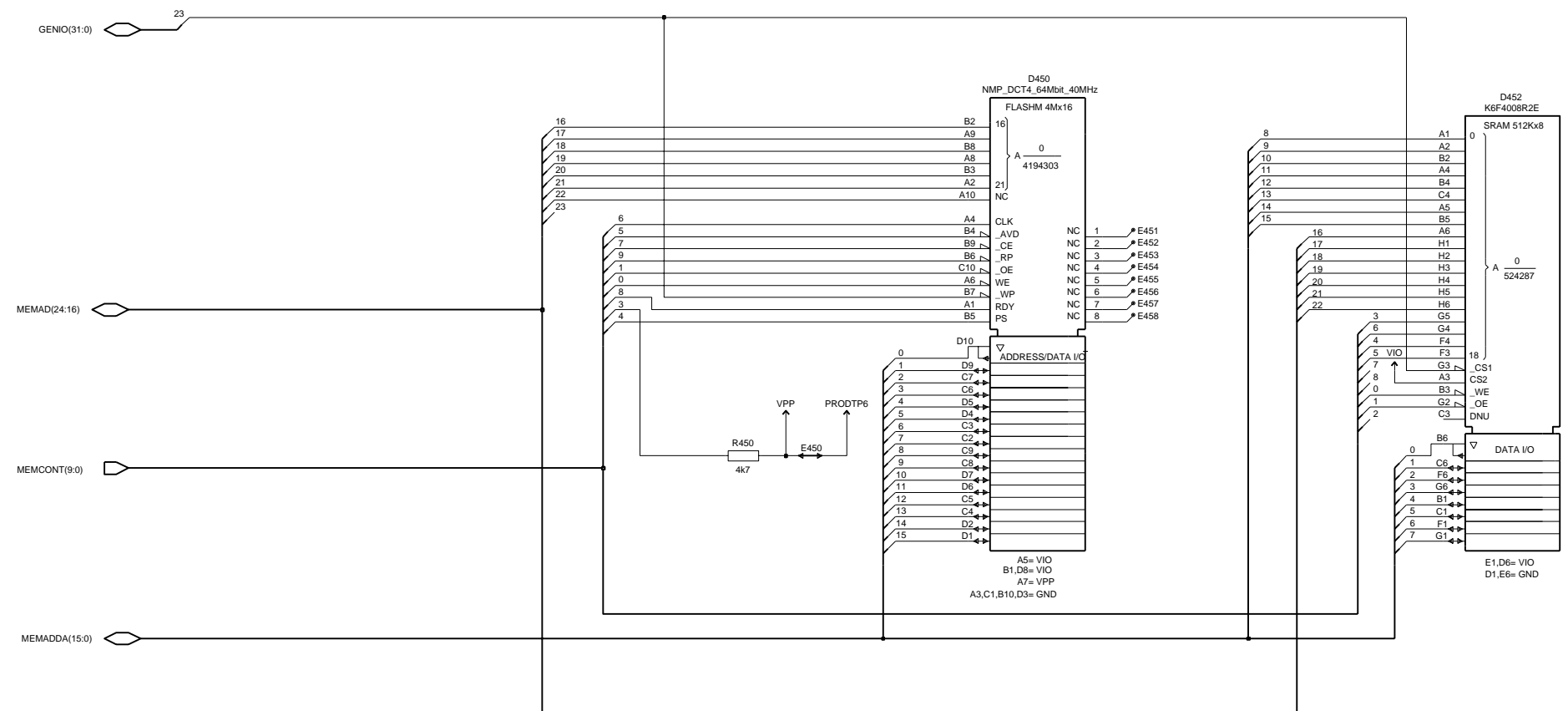
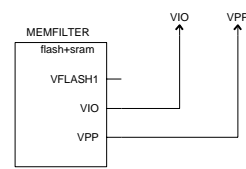

# Memory decoupling

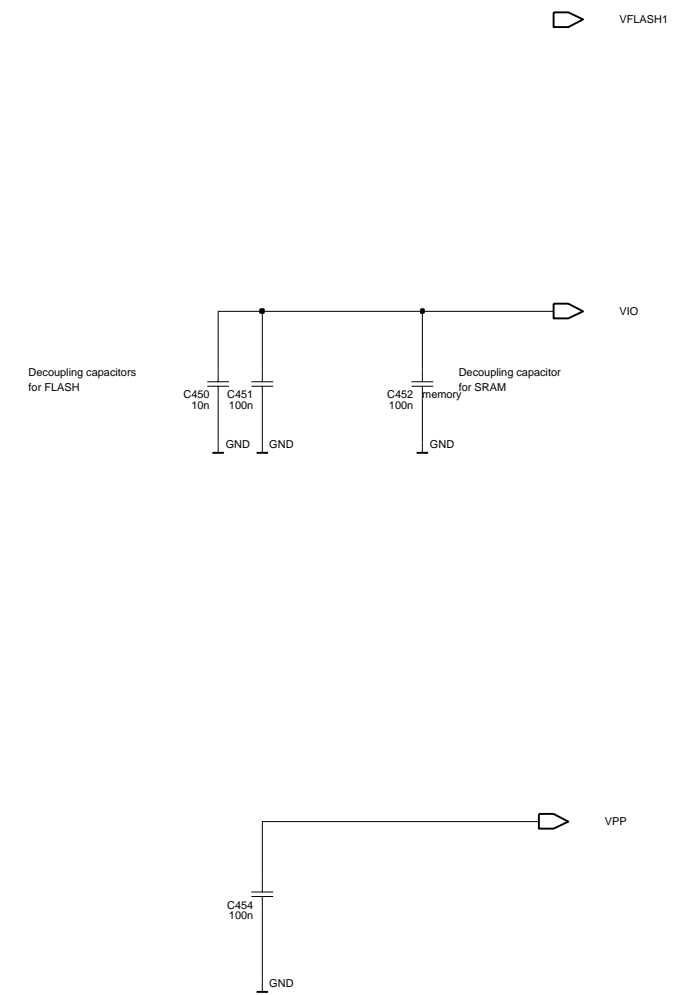

BB-RF

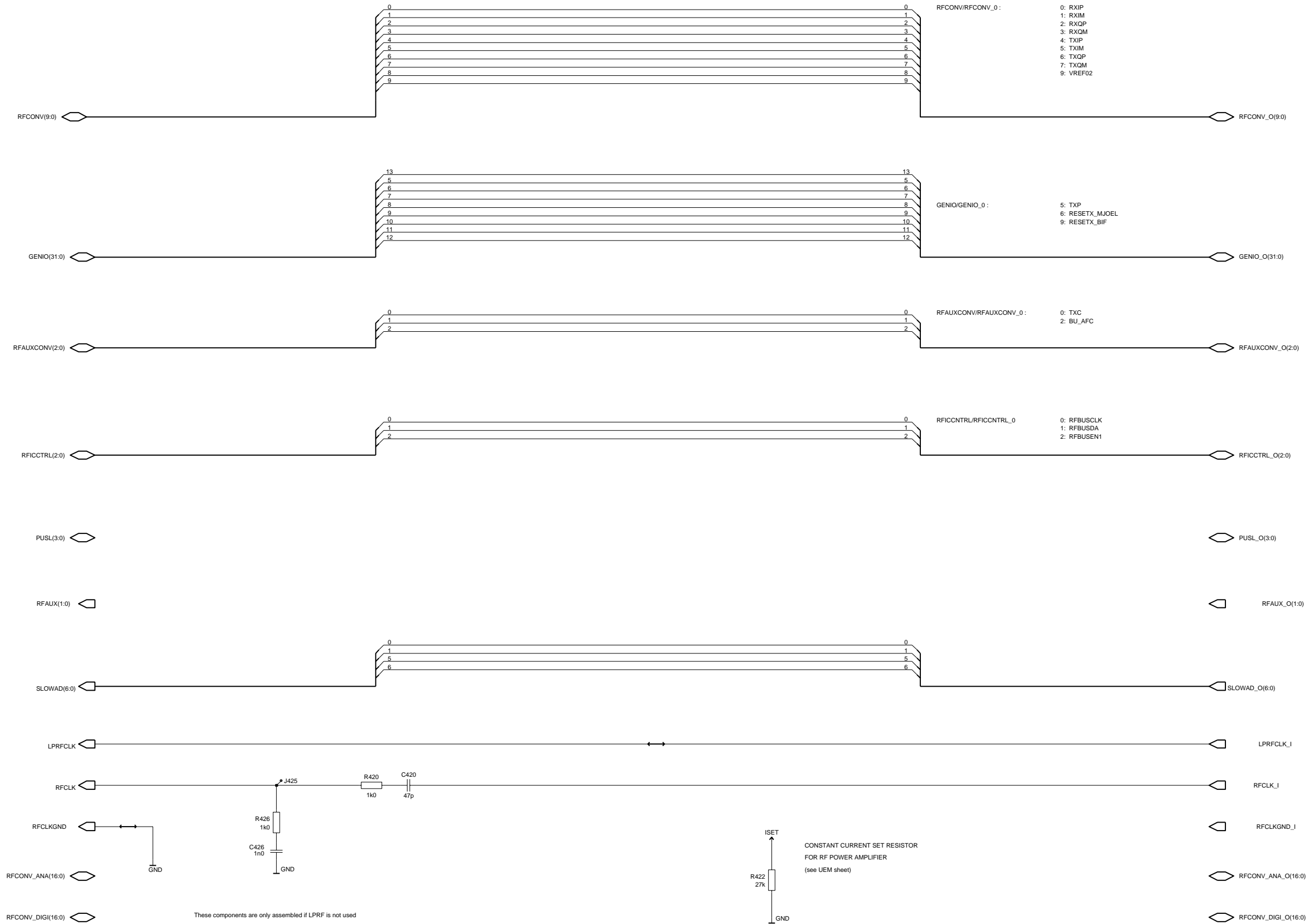

Audio

- PUSL(3:0)
- UIDRV(5:0)
- HOOKINT
- AUDUEMCTRL(3:0)
- IHF(1:0)

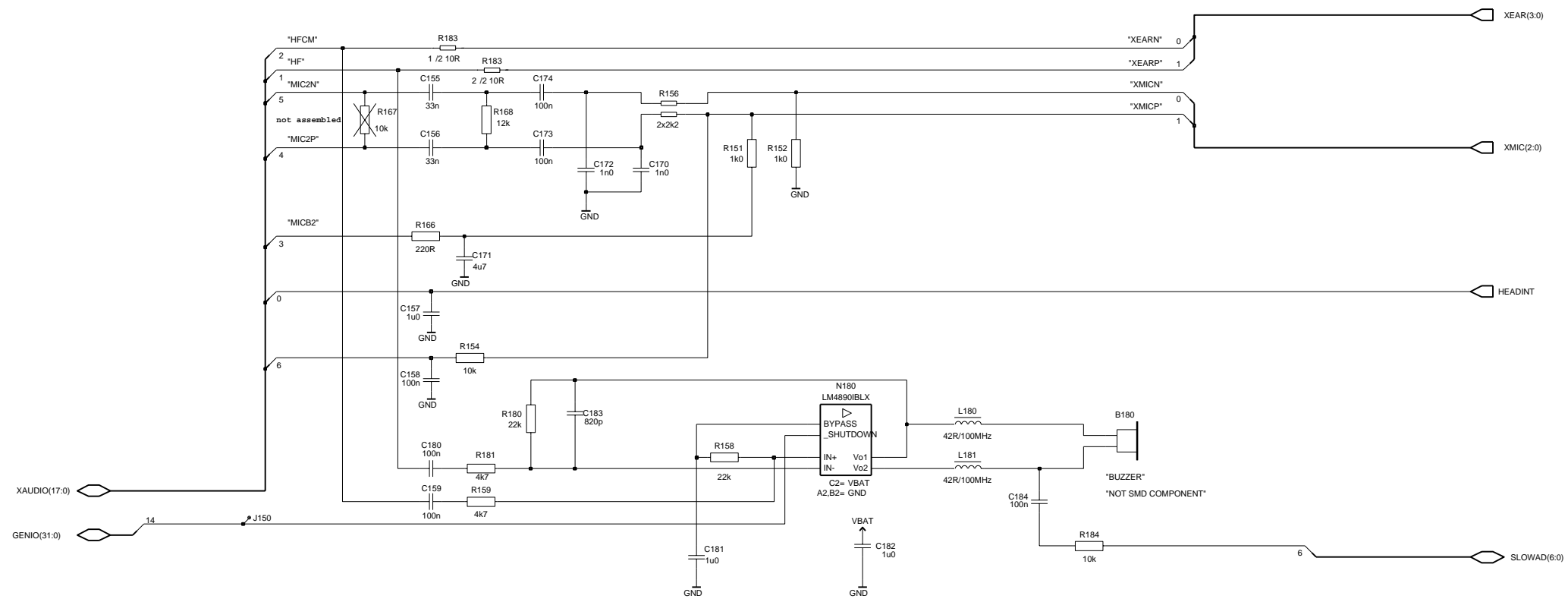
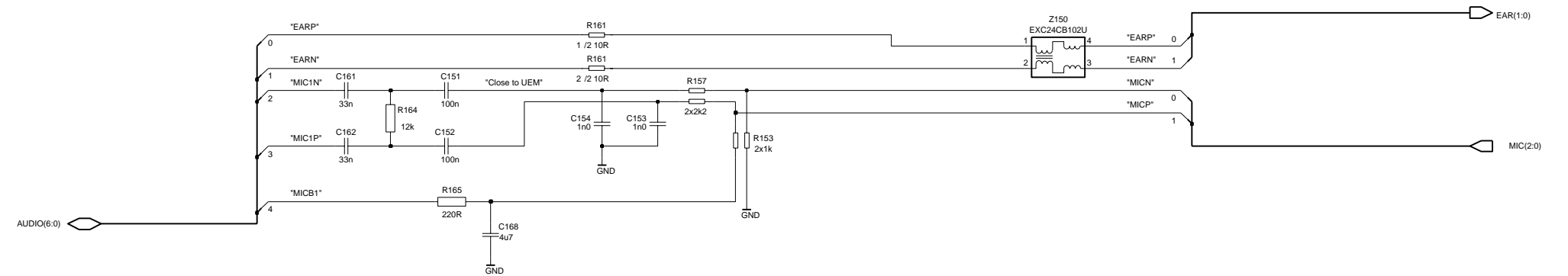



# Multignd

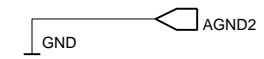
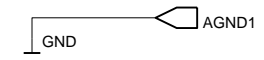
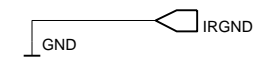

Power amplifier

||

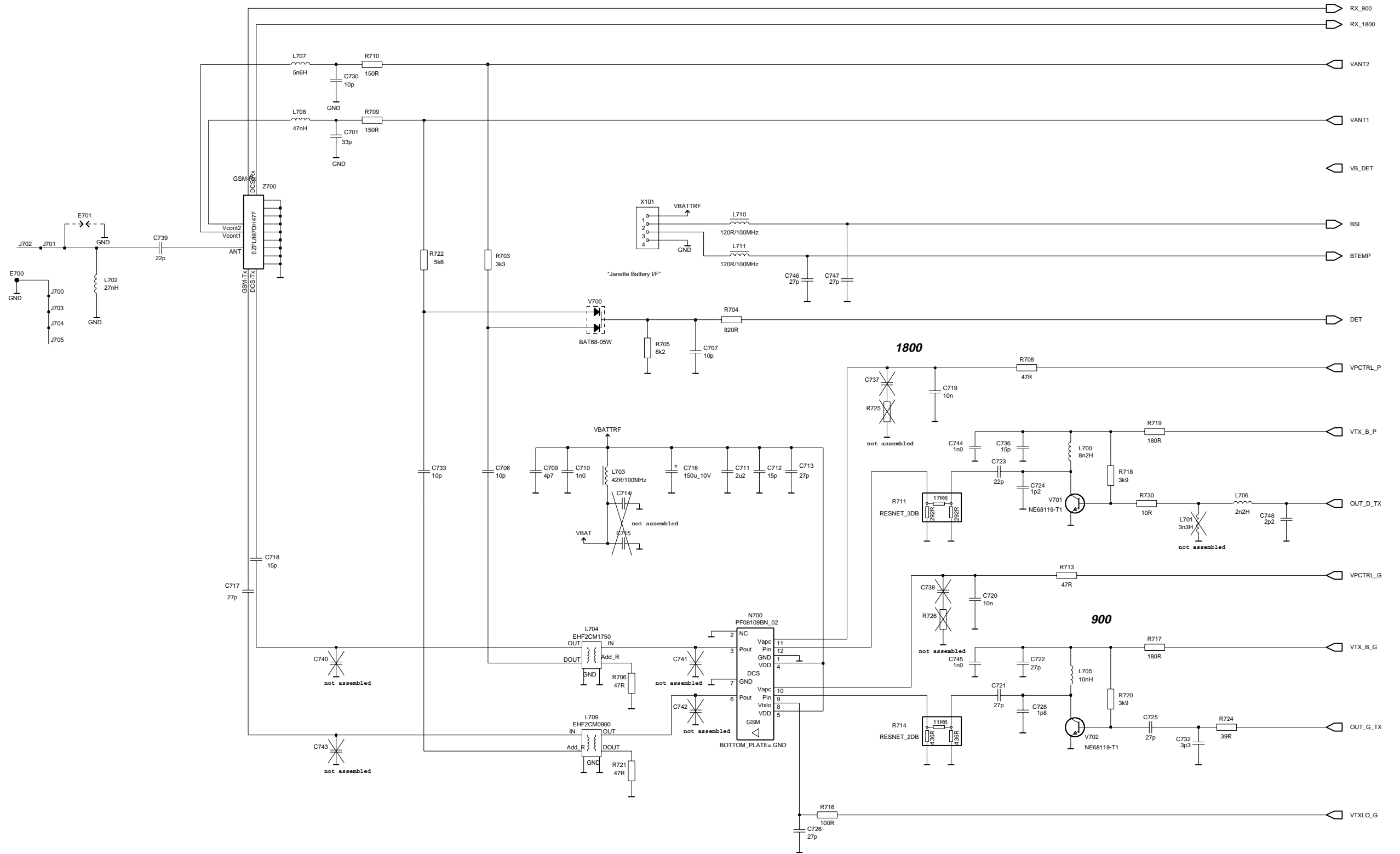

Mjoelner

